

Installation

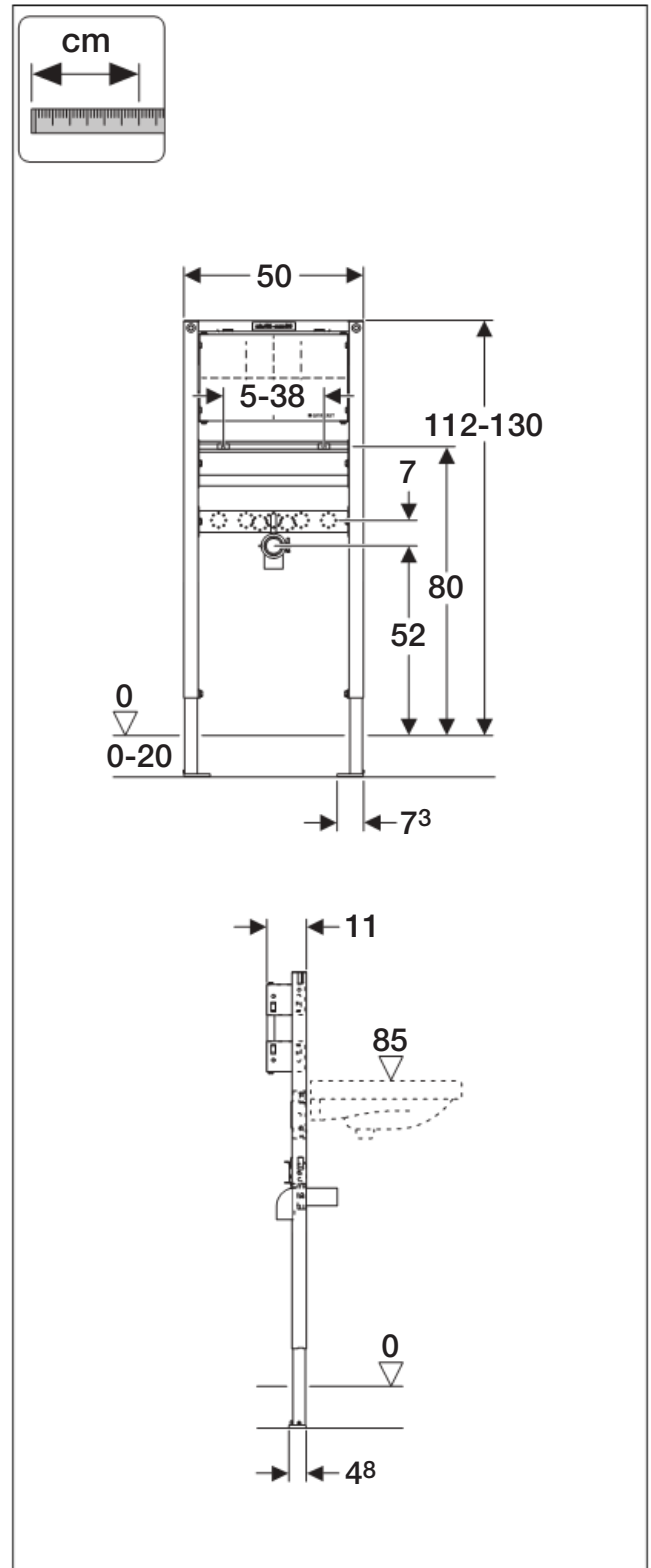

D25387-003&BDC © 06-2009

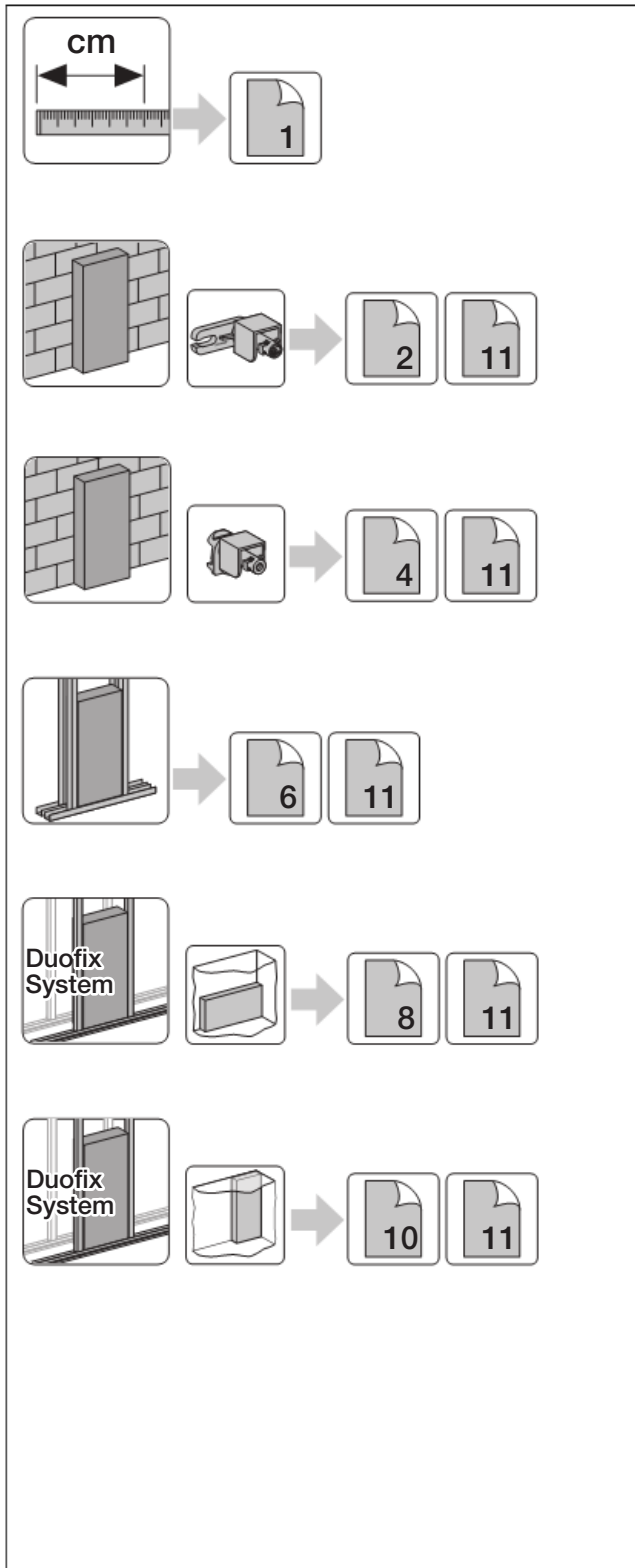

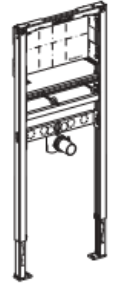
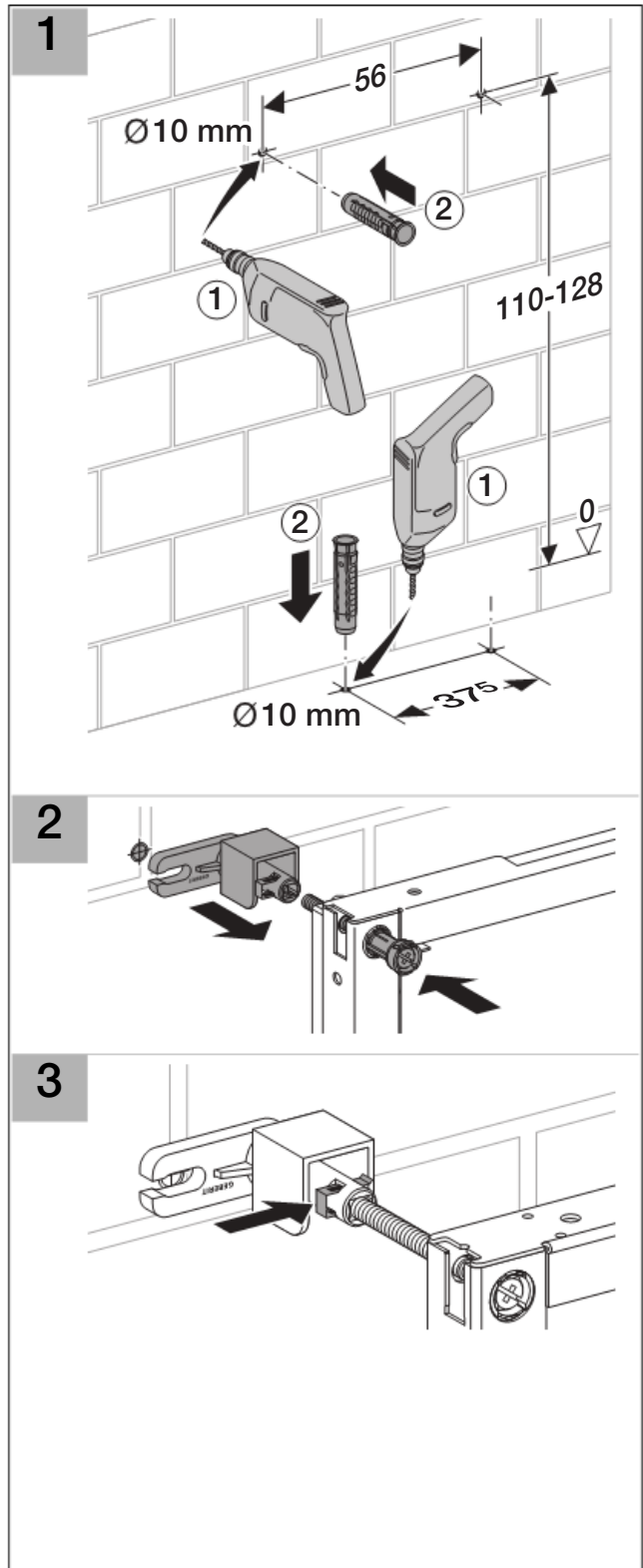
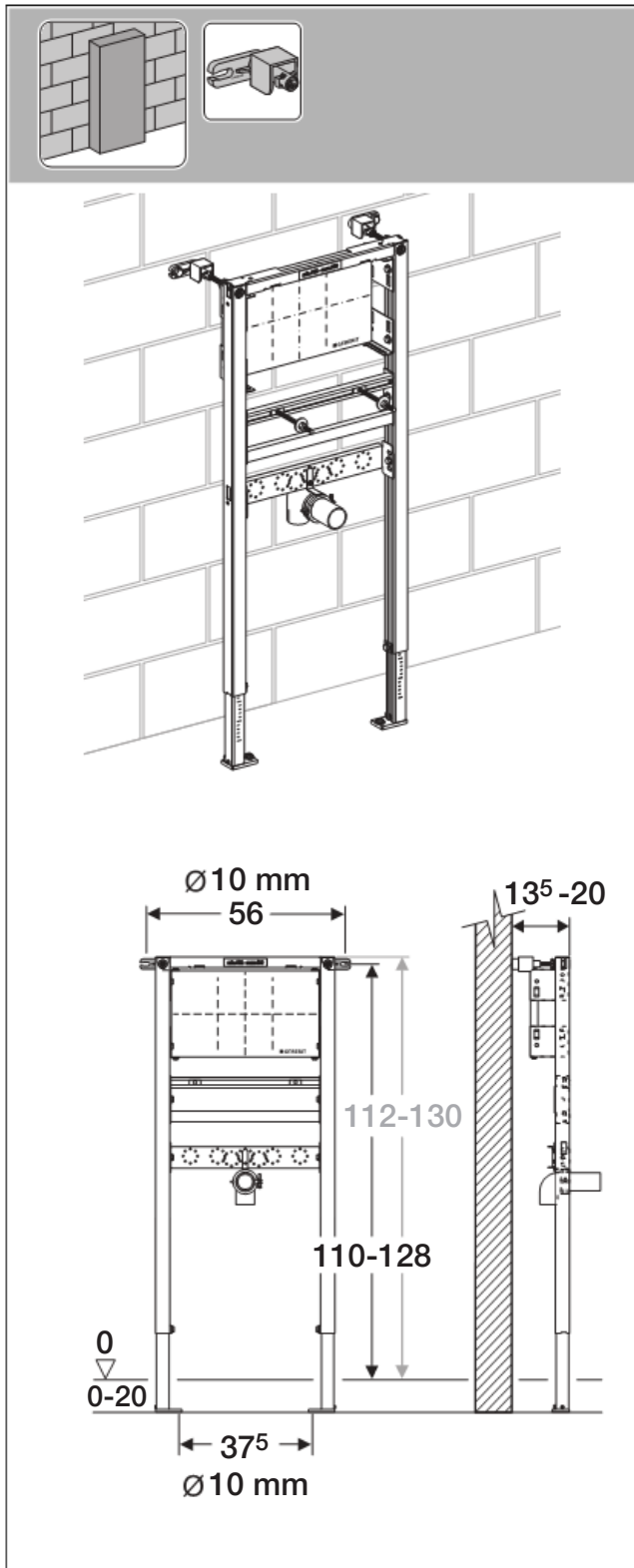
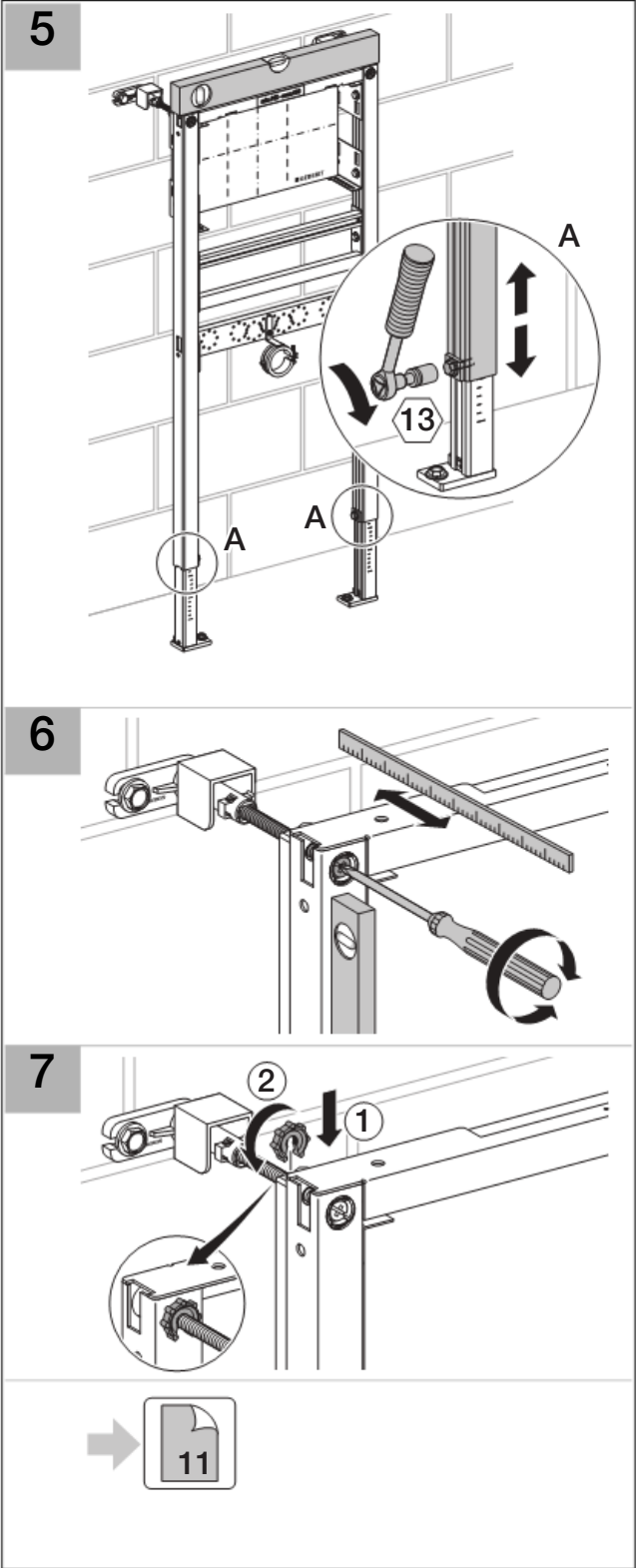
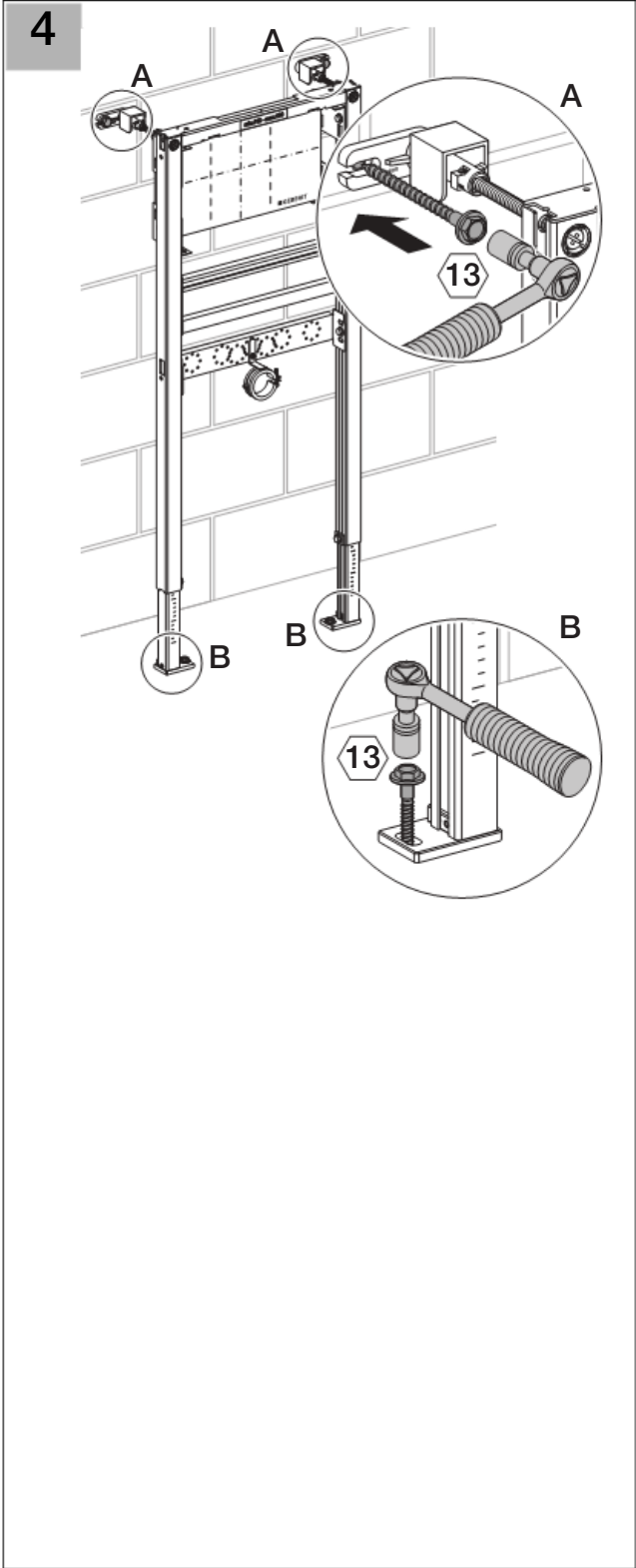

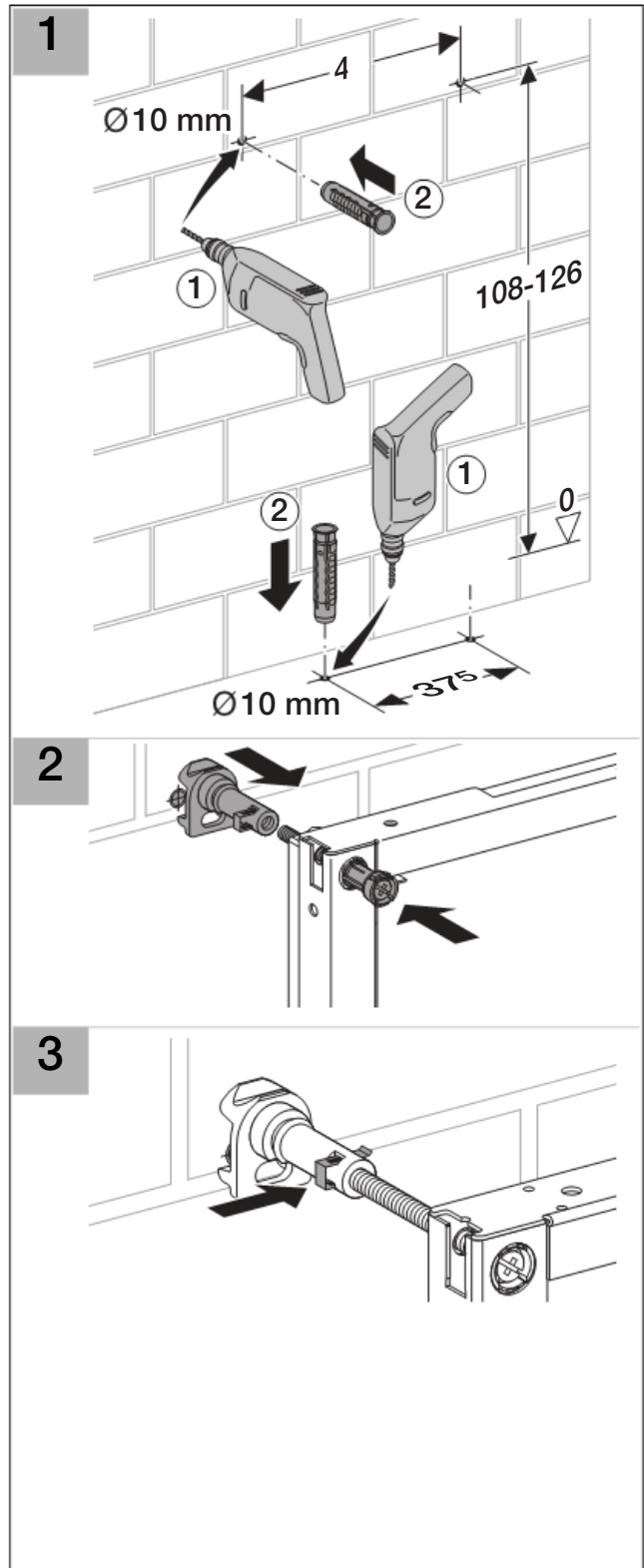
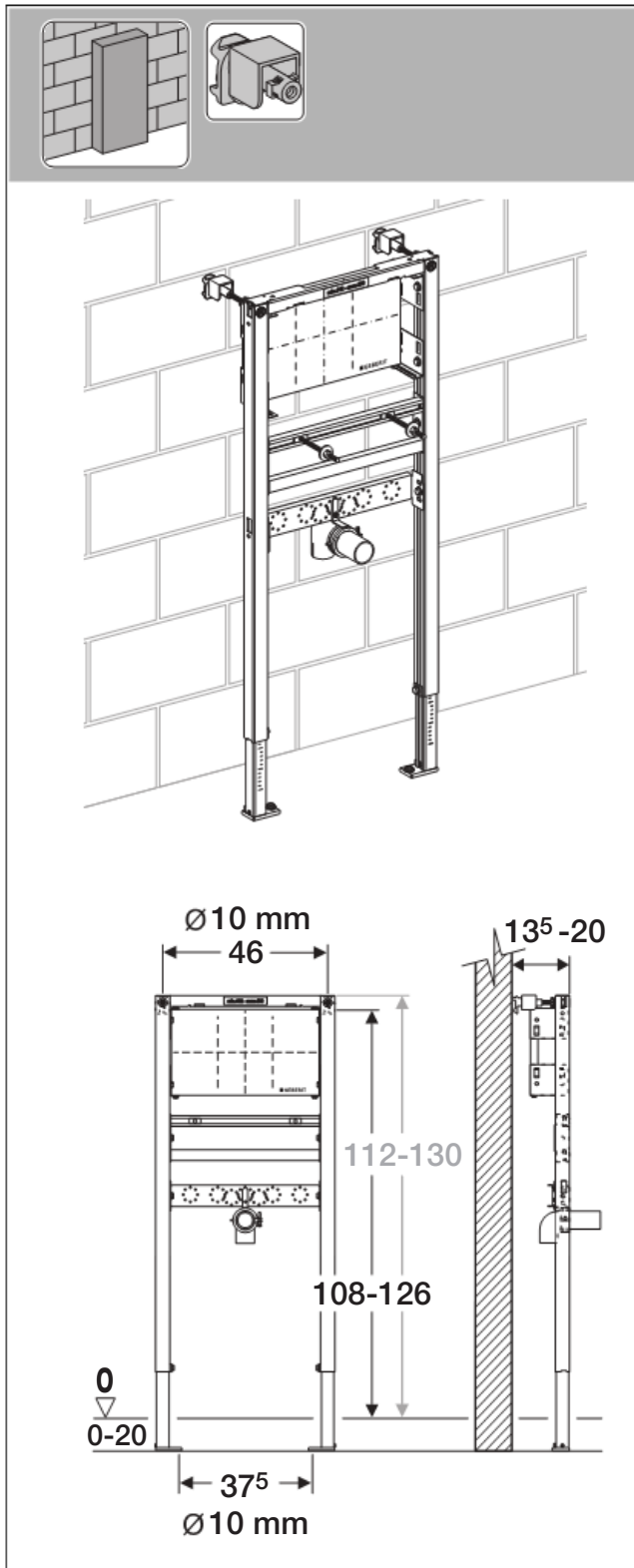

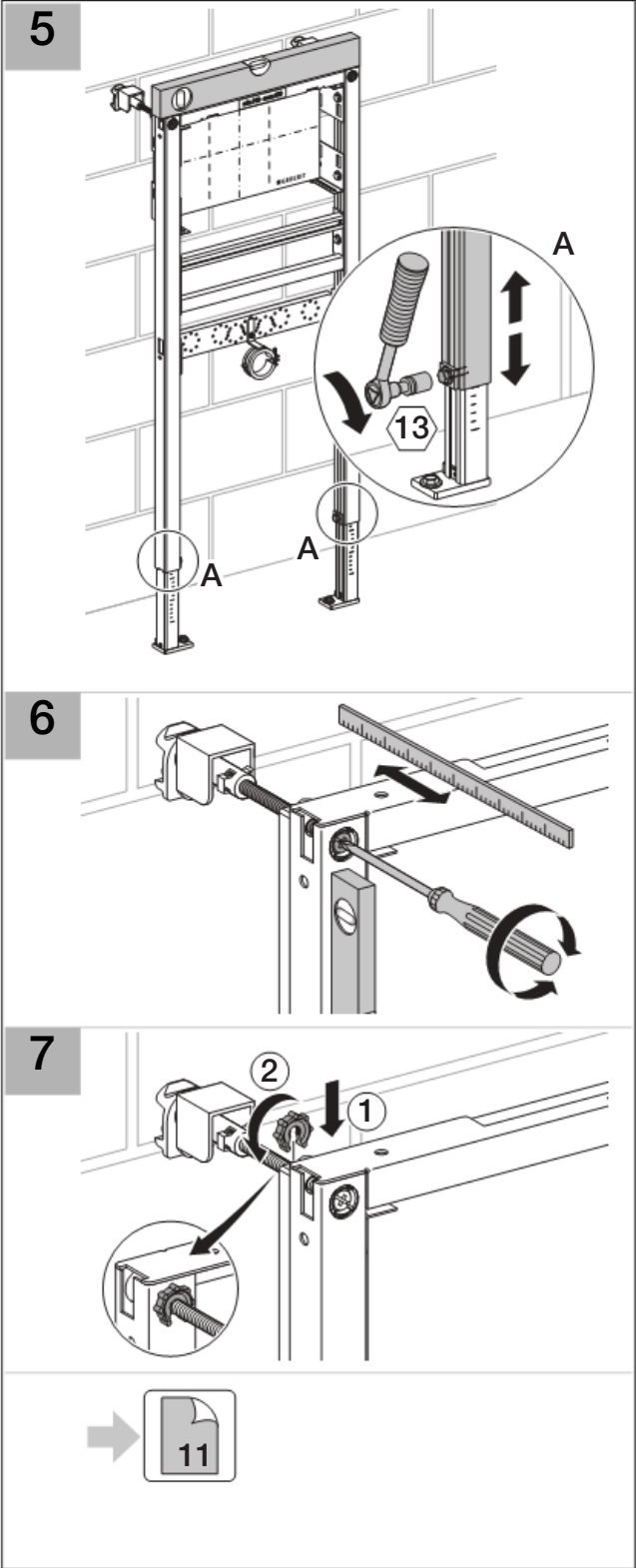
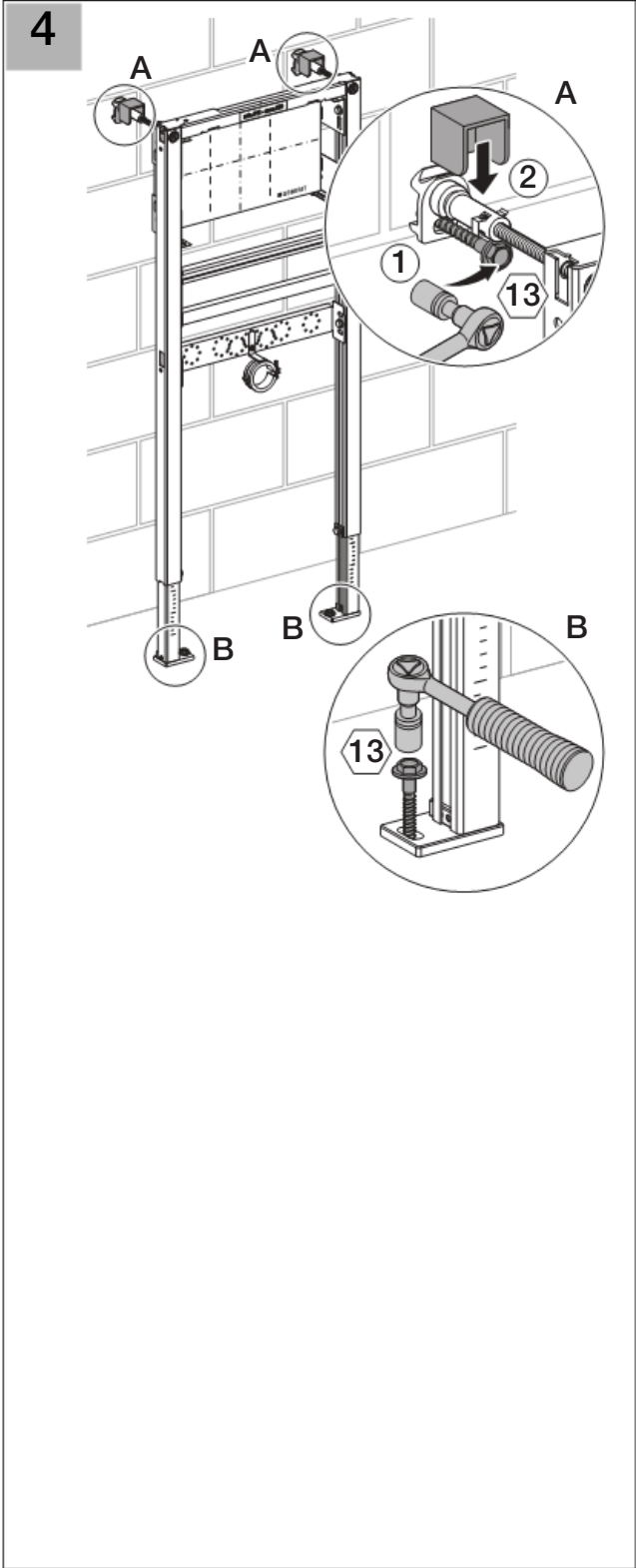

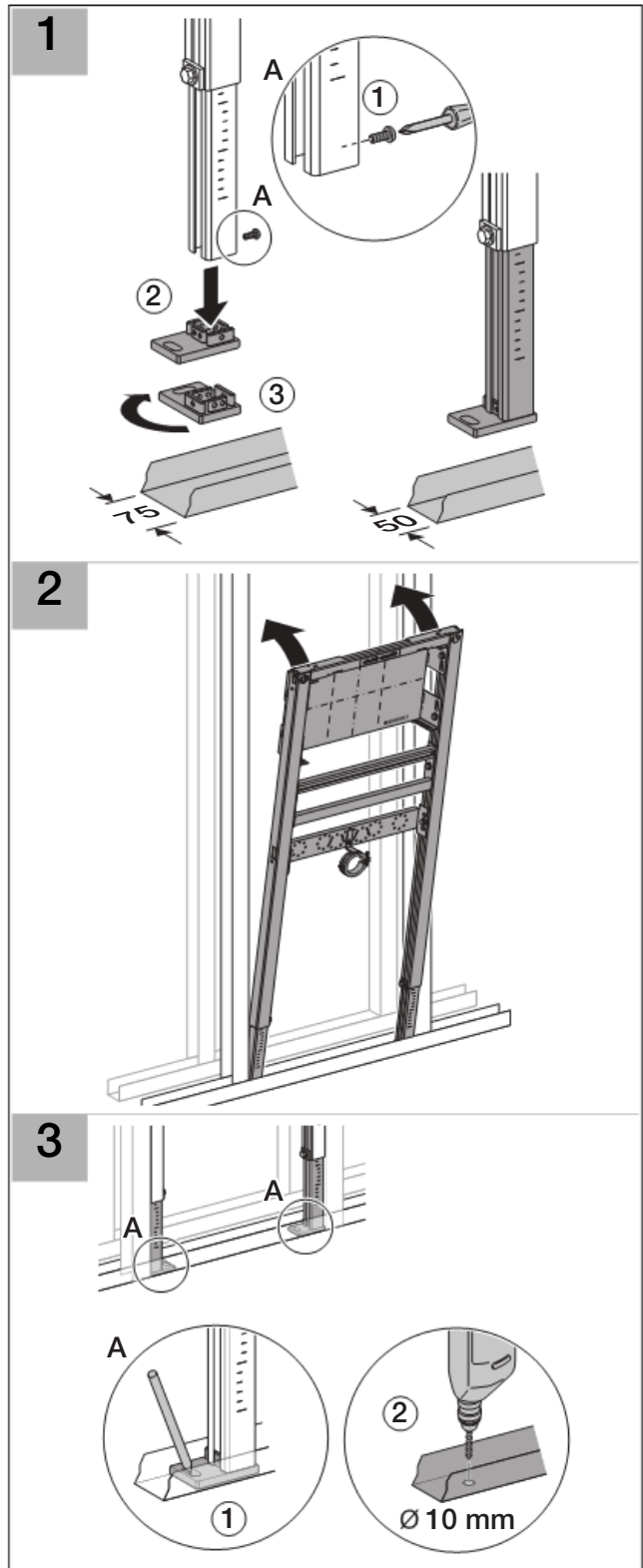
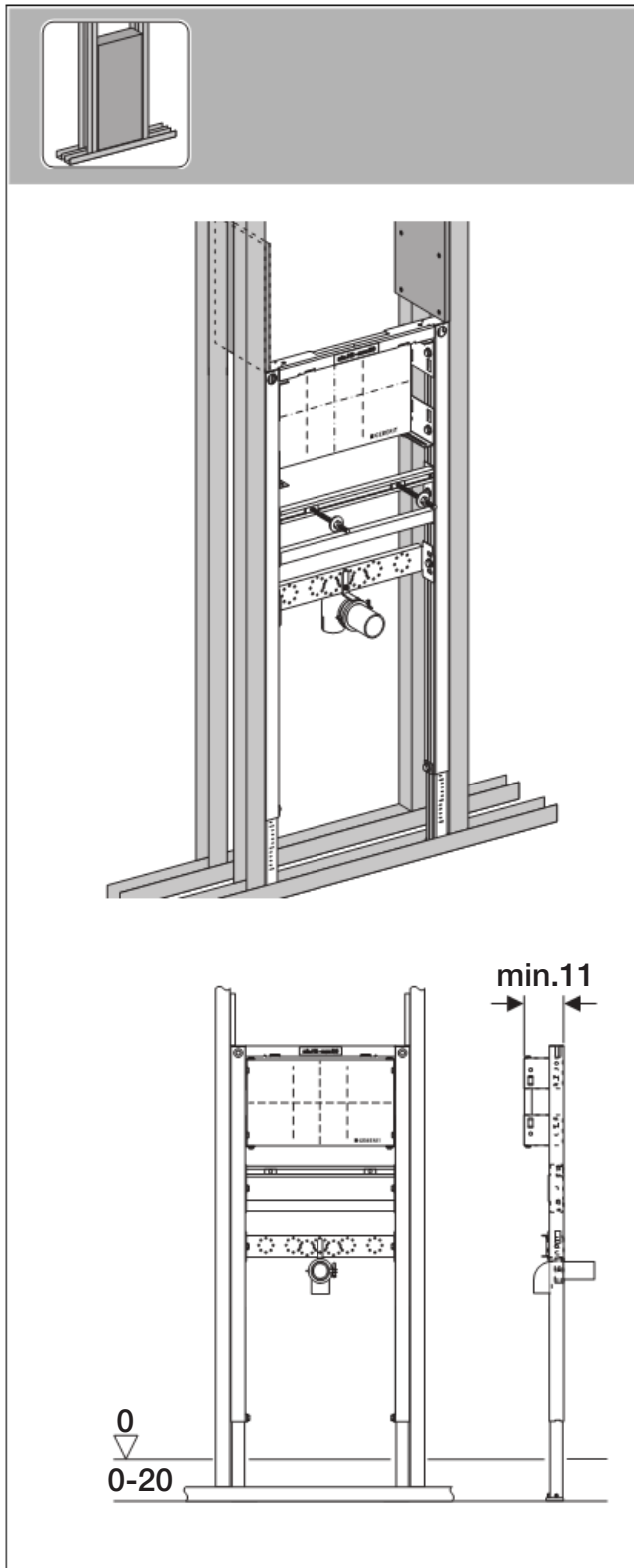

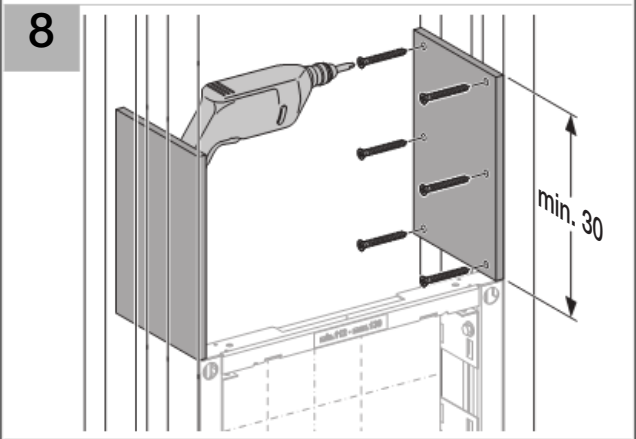
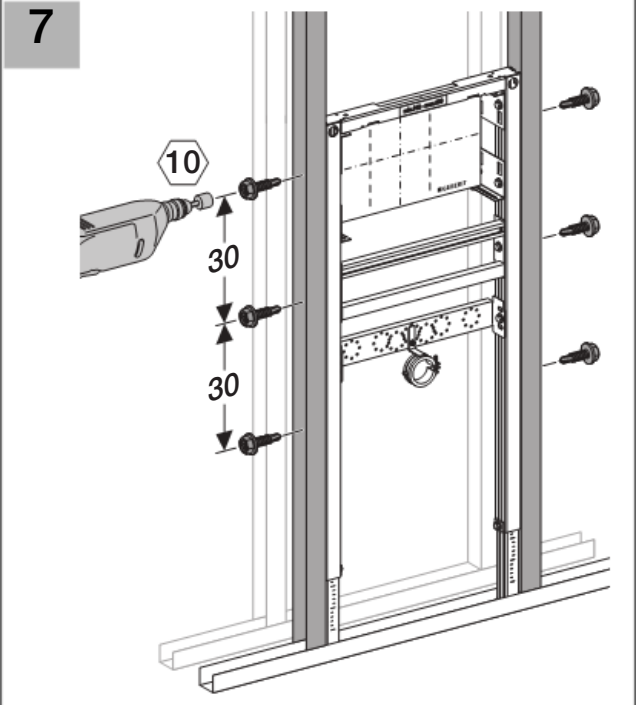
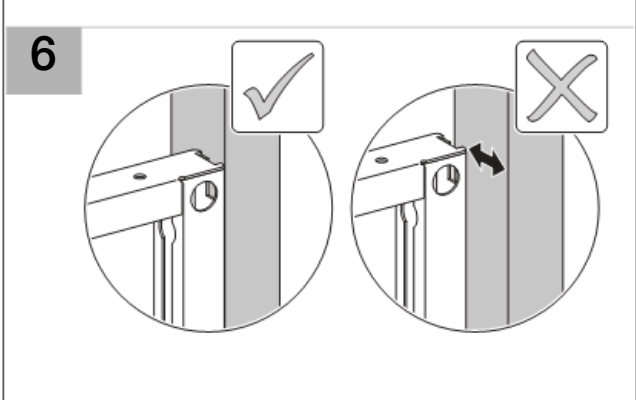
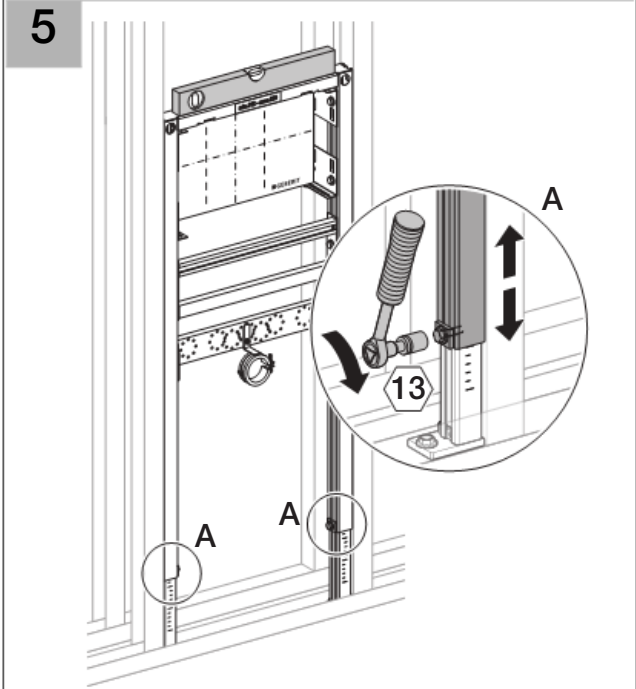
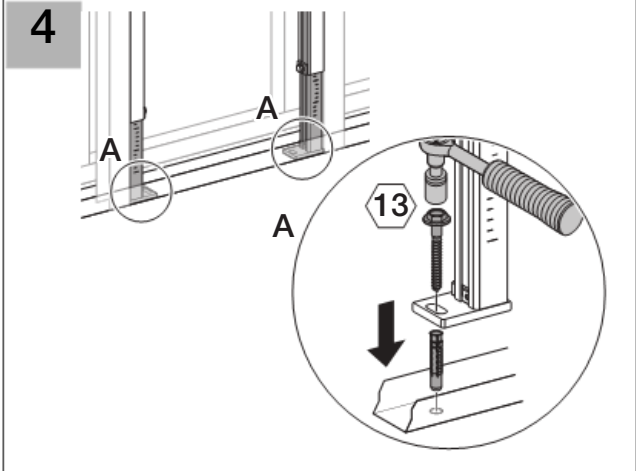

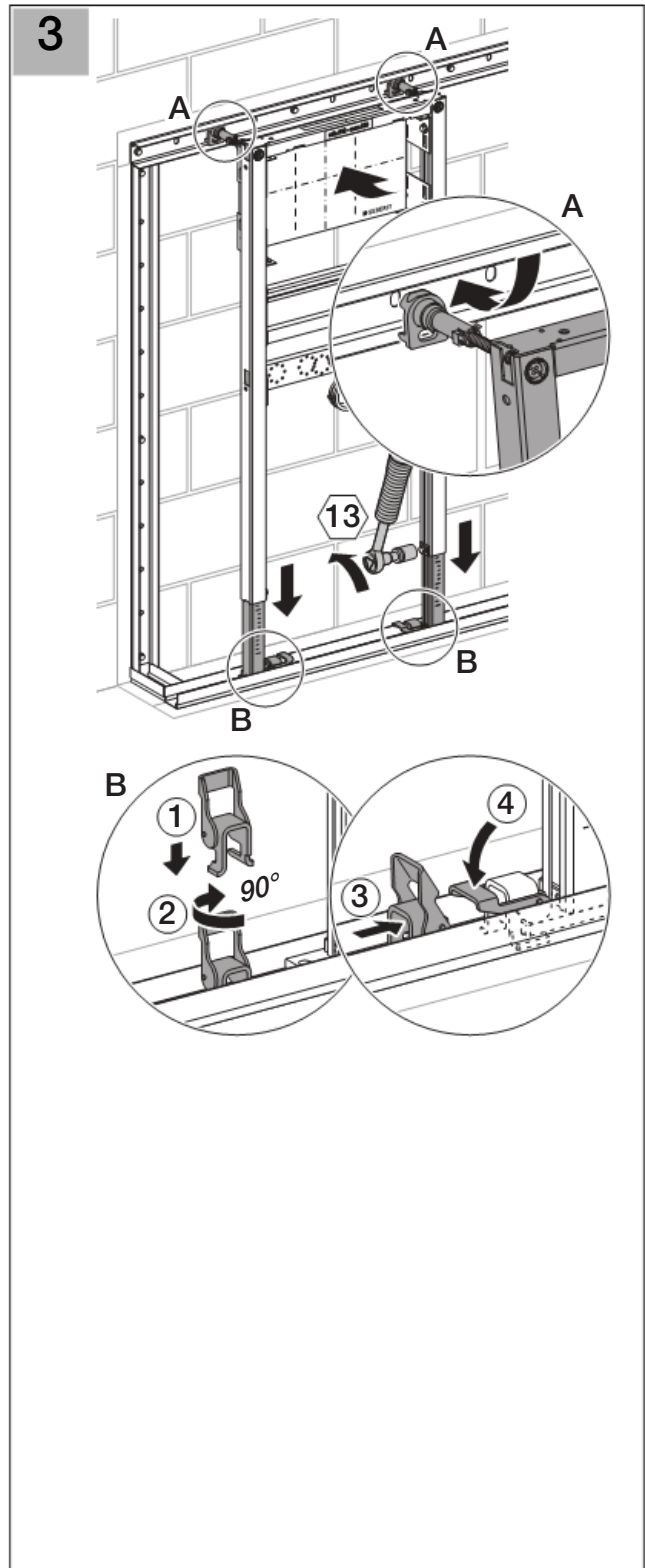
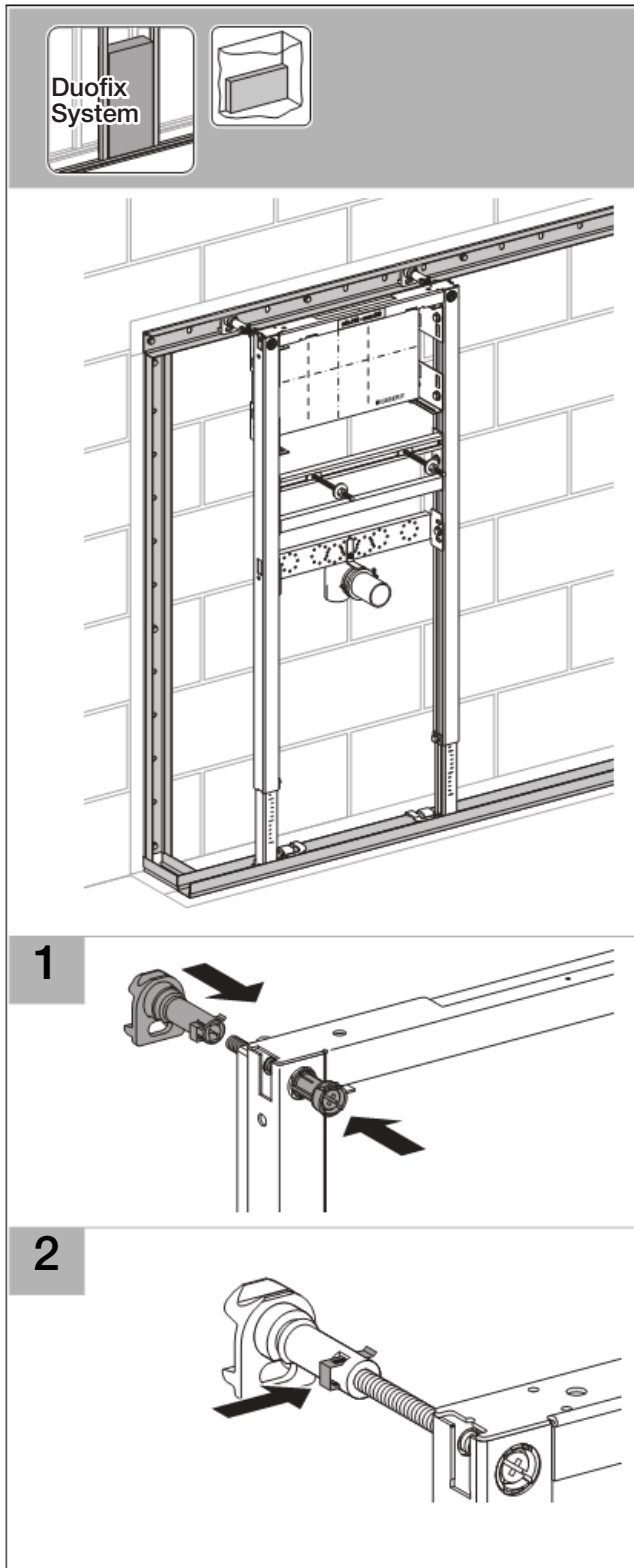

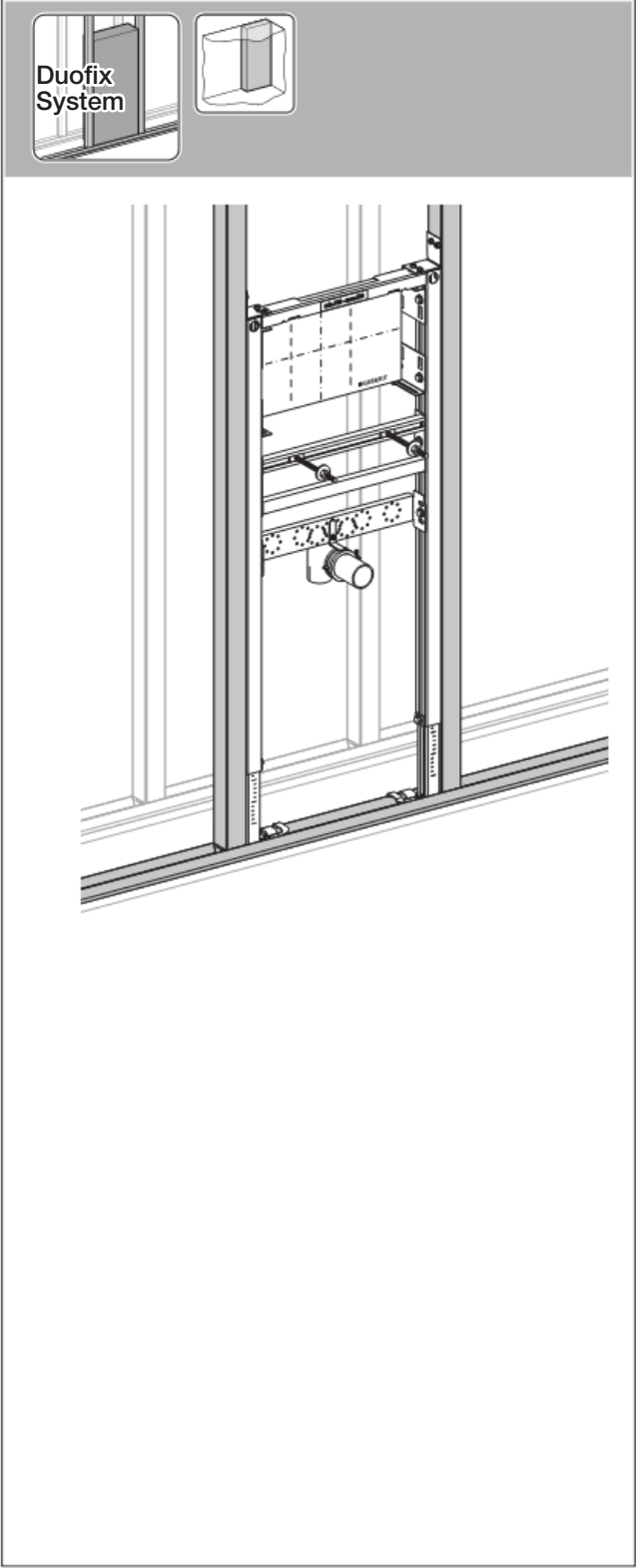
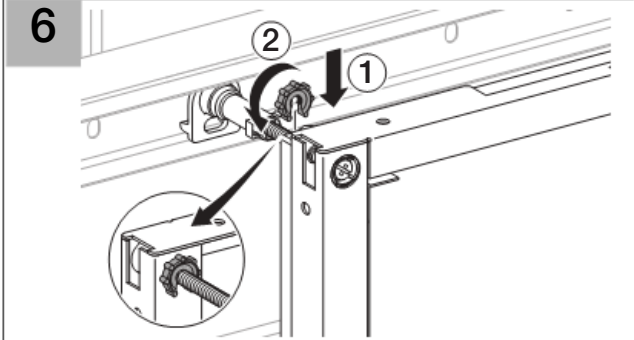
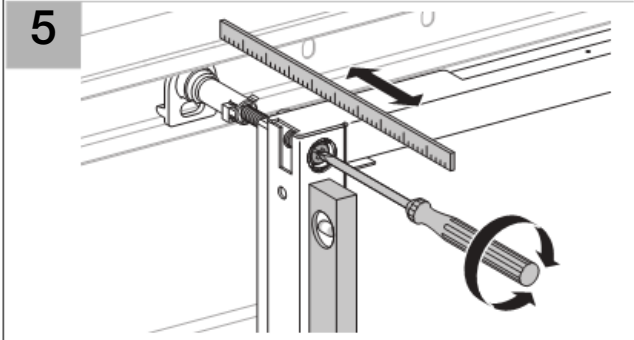
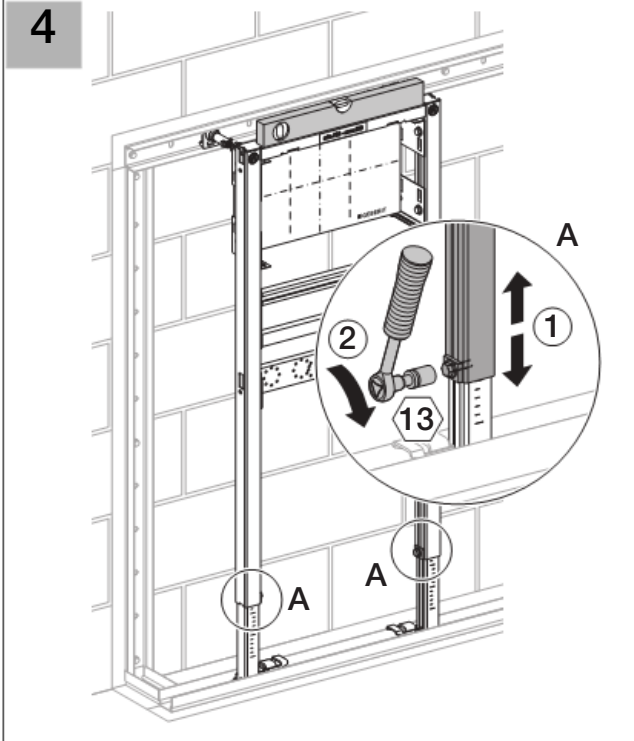

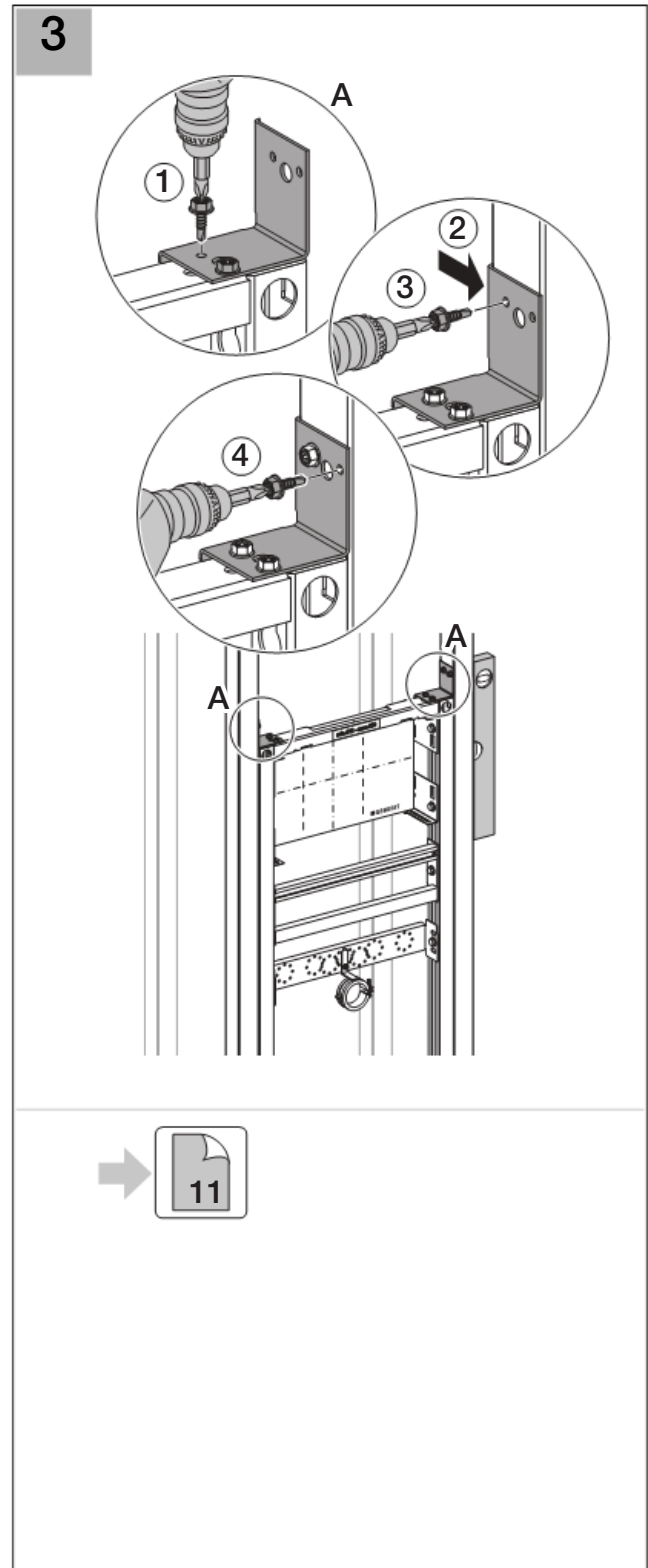
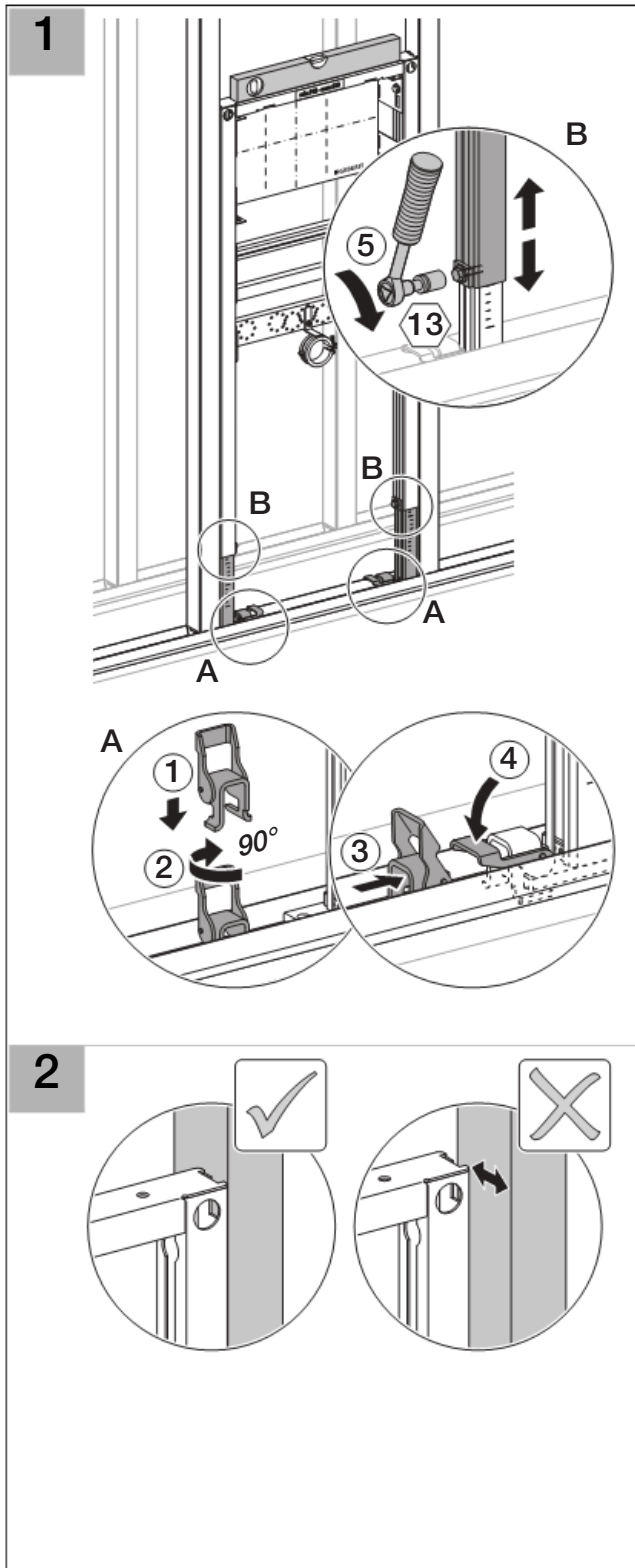

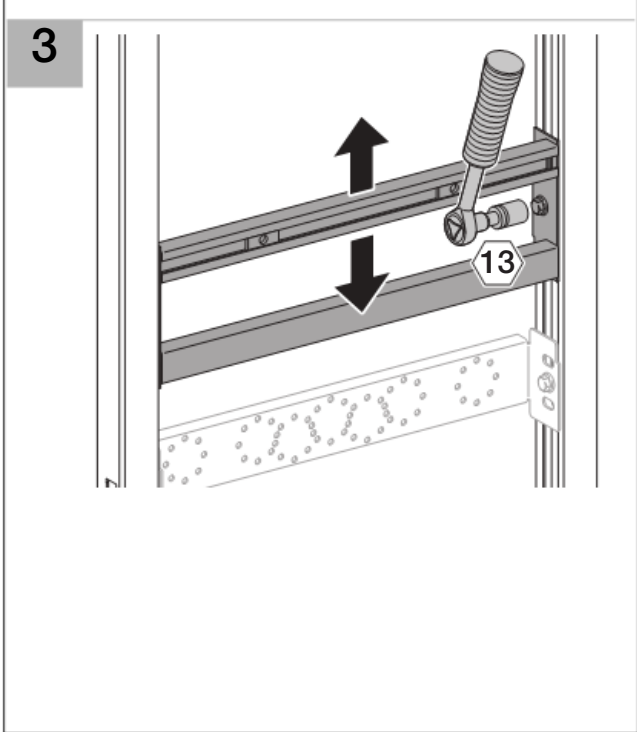
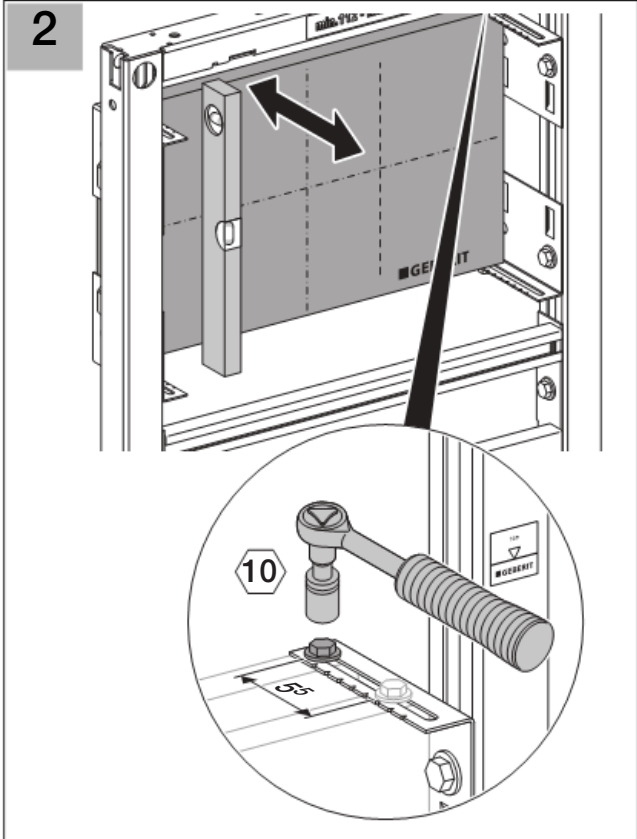
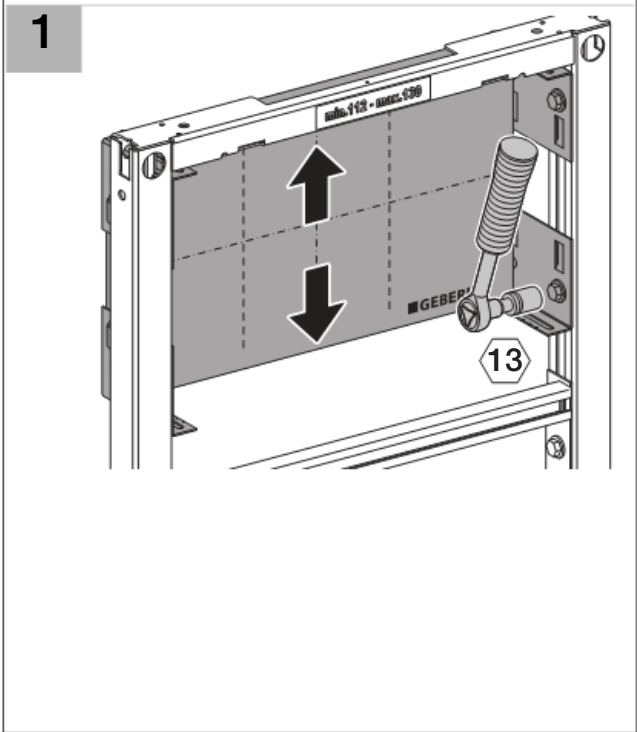
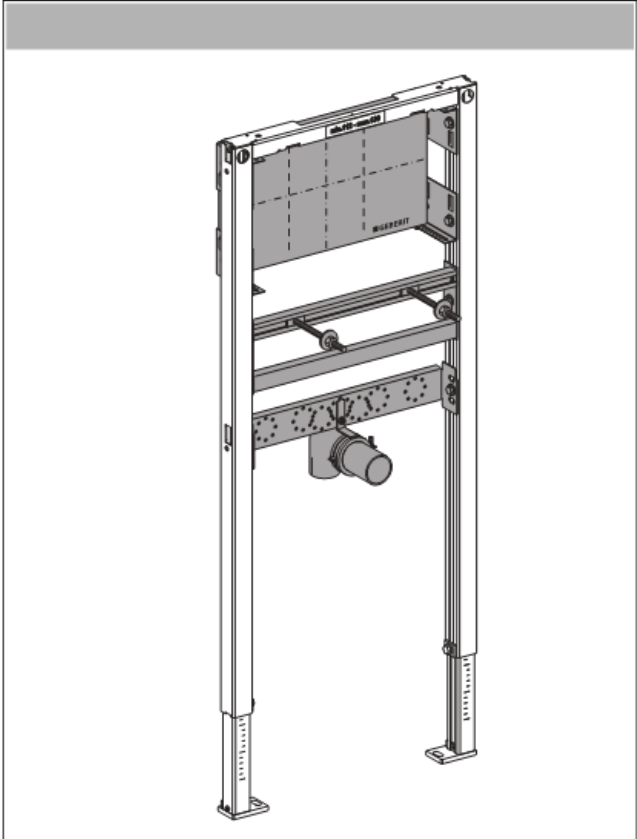

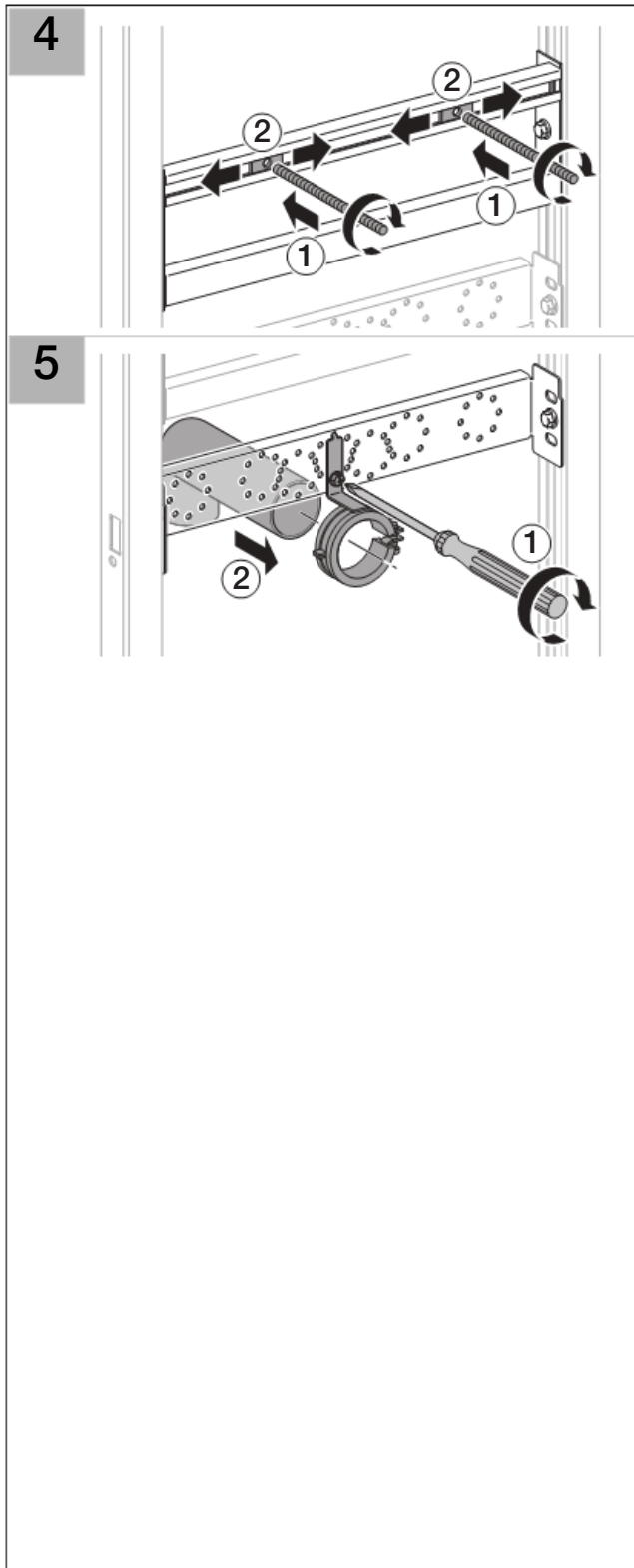

Geberit International AG
Schachenstrasse 77
CH-8645 Jona
www.geberit.com
dokumentation@geberit.com

D25387-003&BDC © 06-2009